

TECHNICAL DATA

Three Phase Electric Motors - Cast Iron Frame
 PE30 355M2-8
 160 kW / 220 Cv
 740 RPM

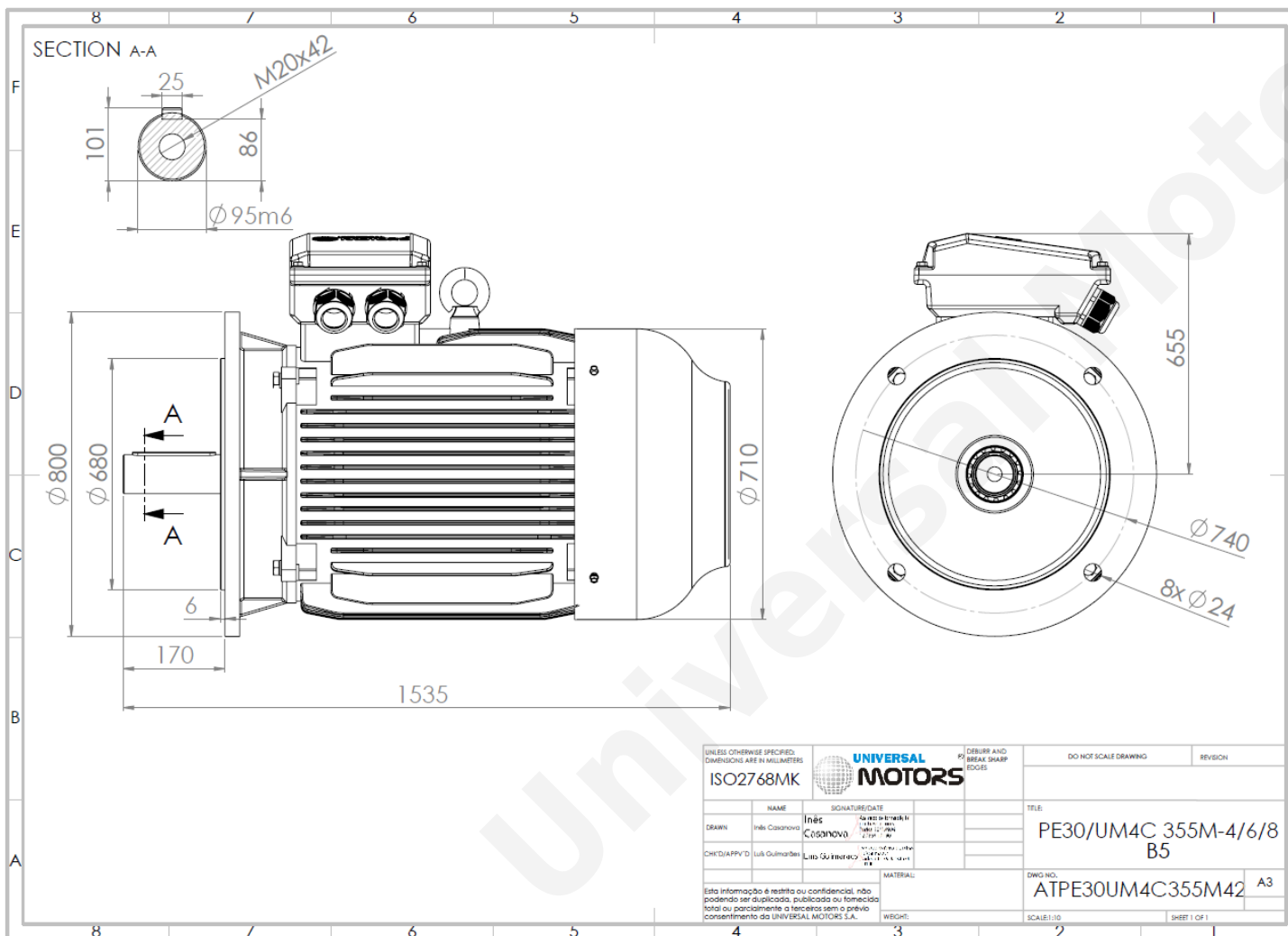

Motor type:	PE30 355M2-8
Output:	160 kW / 220 Cv
Speed (min ⁻¹):	740 RPM
Frequency:	50 Hz
Voltage:	400 V
Current:	298.7 A
Power factor (Cos ϕ):	0.82
Poles:	8
Insulation class:	F
Temperature rise Class:	B
Efficiency 50%:	93.2 %
Efficiency 75%:	94.4 %
Efficiency 100%:	94.3 %
Torque:	2061 N.m
Tstarting/Tnominal:	1.8
Istarting/Inominal:	6.4
Tmaximum/Tnominal:	2.0
Noise:	90 Db(A)
Weight:	2473 Kg
Bearing DE:	NU 322
Bearing NDE:	6322 C3

Regime - S1

Altitude - 1000m

Environment Temperature - 40°C

CONTACTS:

UNIVERSAL MOTORS Tel: +351 252 299 080
 Rua de São Brás,745 Fax: +351 252 299 089
 4480-782 VILA DO CONDE Mail: geral@universalmotors.pt

* References applied only in the UK